

Judogi Regulation

APPLICATION
1st April 2015





IJF CONTACT

Jean-Luc ROUGE
IJF General Secretary

+33 1 40 52 16 35

gs@ijf.org

21-25 Avenue de la Porte de Châtillon
F-75 680 Paris Cedex 14 France

IJF APPROVED LABORATORIES

CRITT Sport Loisirs

Contact : M. Antoine BEAUFILS

Adress : ZA du Sanital, 21 rue Albert Einstein
86100 Châtellerault France
Phone: + 33 5 49 85 73 43
Fax: +33 5 49 21 76 20
Email : recherche@critt-sl.com

JAPAN TEXTILE PRODUCTS QUALITY AND TECHNOLOGY CENTER

Contact: Mme. Yoko OYA

Address: 7-19 Tomizawa-cho, Nihonbashi
Chuo-ku, Tokyo 103-0006 Japan
Phone : +81-3-3666-5384
Phone: +81-3-3666-5390
Fax : +81-3-3666-5394
Email : tk-g8@qtec.or.jp; shimizu@qtec.or.jp



FIG 1 EXAMPLE OF THE OFFICIAL STICK FOR JUDO-GI AND BELT

- ON JACKET
- ON TROUSERS
- ON BELT

1. IJF OFFICIAL JUDO GI

International Judo Federation has established a system of technical approval for Judogi and belt which must be used during IJF official events.

Judogi must have Tag with its Official Label with an optical code provided by IJF which cannot be falsified..

All Judogi for IJF official events must conform to these requirements from **01 April 2015** and must be obligatory with the IJF official Tag (red borders) or else it won't be allowed in competition. Before this date judogis with the former label (blue borders) will be accepted if the measures correspond to the size requested in rules January 01, 2014. Failing that, Judogi will not be accepted in competition. Belts must be with blue or red IJF official Tag.

Only equipment in conformity with IJF rules can be approved



CONDITIONS

Only companies who have signed "IJF official supplier agreement" and who have got a certificate of conformity for their product from one of the IJF approved laboratories (see list in appendix) can obtain the Tag with its Official and unforgeable Label. To become an IJF official supplier, a company must contact IJF General Secretary office for the registration procedure.

gs@ijf.org

CERTIFICATION

If a company approved as an official supplier needs to obtain the Official Label provided by IJF, the manufacturer of the company must produce Judogi and belt in accordance with the rules to one of the official IJF testing laboratories for inspection and approval:



- One white Judogi (jacket and trousers), size 180
- One blue Judogi (jacket and trousers), size 180
- Two samples of the jacket's fabric, part above the belt (grain stitches):
Color: white and blue
Dimensions: length 1,5m, width – width of the roll of the fabric
- Two black belts (Length of the belt to be sent should be between 2,5m and 3m)



REFERENCE

The name or/and the reference number shall be distinctly visible on the jacket, trousers and belt.



CONTROL

All products during an IJF event which are controlled non-compliant will be the object of an investigation. If the supplier is recognized incorrect, a penalty going up to the withdrawal of the IJF agreement can be pronounced by the Office of the IJF. If it is the competitor or his team who are recognized incorrect, they will be sanctioned by the IJF office.

2. GUIDELINE FOR JUDOGI MANUFACTURERS

The Judogi quality is essential so that the opponent executes his technique, it is compulsory that every judogi is of property identical

2a Fabric material

2a(1) The fabric for Judogi must not be too thick, too rigid and too slippery for the opponent to take a grip.

2a(2) The fabric of Judogi must be cotton or cotton blend with more than 70% Cotton, and must have good hand-feeling. Blending components other than cotton (less than 30%) can be chemical fibers, such as Rayon, Nylon, Polyester, etc.

Note : *The use of chemical fiber will increase the strength and reduce the weight of the fabric. On the other hand, too much use of chemical fibers makes the fabric less sweat-absorbing.*

2a(3) The fabric must have an appropriate solidity. Therefore, weaker fabric must not be used intentionally.

2a(4) The fabric weight (after new and unused jacket is washed and dried) must be between 650g/m² and 750g/m².

2a(5) Judogi white must have the color of cotton, that is, natural white or off-white.

2a(6) The official standard color for Judogi blue must be between Pantone number n°18-4051TCX(TPX) and n°18-4039TCX(TPX) on the textile Pantone scale and between n°285M and n°286M on the print Pantone scale.

2b) Fabric weave system

2b(1) The jacket of Judogi is composed of two parts, upper jacket part (approximately above the belt position) and lower jacket part (approximately below the belt position). Upper jacket part must be Sashiko-weave fabric. (Sashiko is like grain stitches.)

The lower jacket part must be light-weight and strong plain-weave or twill-weave fabric, which is combined with diamond patterned Sashiko weave.

(See the illustrations, Fig. 11, Fig.12, Fig.13)

Note 1: *Lower jacket (lower side) part needs lightness rather than strength, therefore, diamond -patterned fabric is generally used. (More yarns, heavier is the weight.)*

Note 2 : *Fabric face must be on the right face of Judogi, and reverse use is not allowed.*





Float

Textile

PLAIN WEAVE –FIG 2-

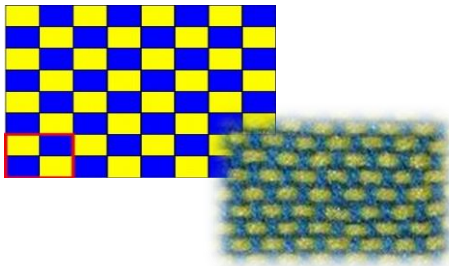

TWILL WEAVE –FIG 3-

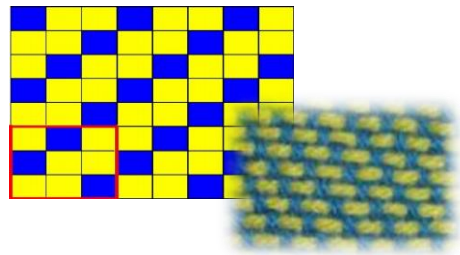

The red square is just showing the repetitive weave system.

2b(2) Sashiko yarn direction must be horizontal when Judogi is placed vertically (when in use). Note : Horizontal Sashiko yarns increase the fabric strength against horizontal tensile force. When the direction is vertical, the fabric becomes slippery causing difficulty of handgrip.

2b(3) Upper jacket part must be double-woven Sashiko fabric having enough strength to resist a 2200N traction.

2b(4) Number of float of Sashiko yarn must be 3 to 5 per inch (inch = 2,54 cm) after washed and dried.

SASHIKO –FIG 4-

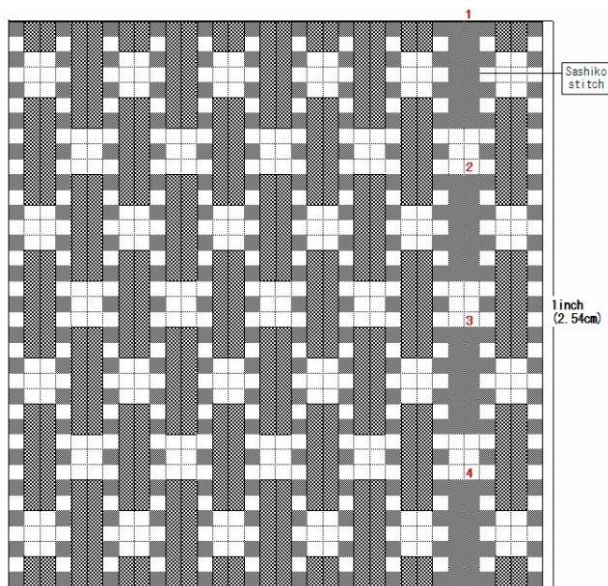

2b(5) New and unused product after washed and dried must be within the range bellow:

Sashiko yarn and basic fabric weave (inch = 2,54 cm)

Yarns per inch (2.54 cm) for warp and weft (after washed and dried)

Sashiko Yarn (warp)
±5% Tolerated

Yarn count	Per inch
10–5 ply	18 to 25
20–12 ply	18 to 25
10–6 ply	18 to 25
20–10 ply	18 to 25

Ground warp Yarn
±5% Tolerated

Yarn count	Per inch
10–one ply	70 to 96
10–2 ply	34 to 48
20–2 ply	70 to 96

Welt yarn
±5% Tolerated

Yarn count	Per inch
20–3 ply	70 to 88
10–2 ply	56 to 80
10–4 ply	28 to 40

-FIG 5-



HOW TO CHECK THE NUMBER OF WARPS AND WEFTS?

1. Prepare a loupe for textile use by which yarns in 1 square inch can be observed. (left picture)
2. Count the number of warps per inch for the surface fabric.
3. Count the wefts after removing warp yarns and Sashiko yarns from the fabric.

2b(6) The fabric for trousers and jacket collar must be twill weave.

2c) Sewing specifications

2c(1) Jacket

- Sashiko covering dimension must be in the range of 50 - 55% of the finished whole jacket length. Judogi for over 190 cm height, the range can be 45 - 55%.
- Sashiko part must not have sewing stitches other than at back joint, both side body, and both sleeves, except upper-lower joint. (See Fig.12, part D)
- Width of collar must be 4 cm maximum. Collar must be sewn with 4-rows. (Fig.8)
- The color of inside-collar fabric must not be seen from outside.
- The collar thickness must be up to 1 cm except the part including sewn seam in case that sewn seam is placed in the jacket back and extended to the collar.
- Collar assembly which sandwiches body Sashiko fabric and chest pad fabric must be in accordance with the following points (2c(1)a, 2c(1)b, 2c(1)c, 2c(1)d).

2c(1)a Outer part of collar (essential part)

- Twill weave cotton or cotton blend with more than 70% cotton fabric must be used (chosen from the three types):

-FIG 6- TWILL WEAVE 2.1

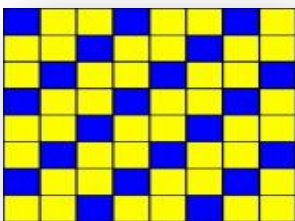

TWILL WEAVE 3.1

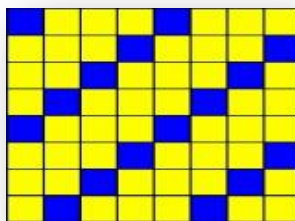

TWILL WEAVE 3.2

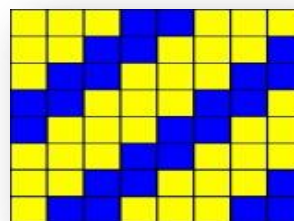

Yarn must be thinner than yarn count 10s. (2-ply yarn having equal resulting count can be used to increase strength.)

2c(1)b Reinforcement fabric for the collar (if used)

In the case of using reinforcement fabric for collar, cotton fabric with plain or twill weave.

-FIG 7- TWILL WEAVE 2.1

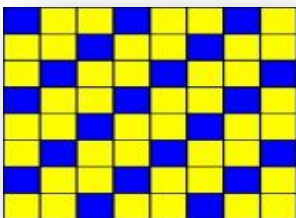

TWILL WEAVE 3.1

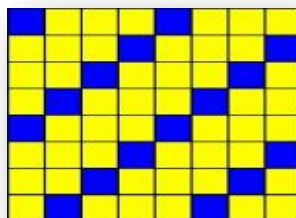

TWILL WEAVE 1.1

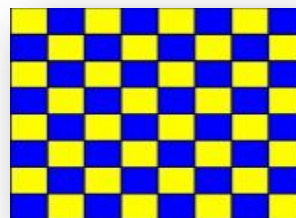

Yarn must be thinner than yarn count 10s.

2c(1)c Main core material (essential part)

Main core material for collar must be one of the 4 materials, throstle spun yarn fabric (Garabo), non-woven fabric, felt, or diamond -patterned fabric.

2c(1)d Sub core material (if used)

In the case of using sub core material, use a material as specified in 2c(1)c.

FIG. 8 THE COLLAR:

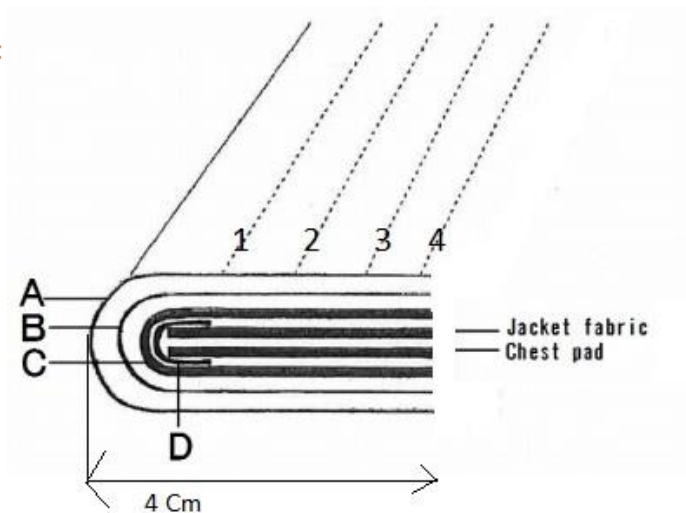

Note: The purpose of specification above is to prevent collar from becoming too hard to grip by setting the upper limit on the collar thickness.



HOW TO CHECK THE HARDNESS OF THE COLLAR (AFTER WASHED AND DRIED)

- 1 Fold the collar, at the chest pad inserted part, into two and place
Note: At this time, do not touch around the folding axis to avoid any pressing force.
2. The height (width) of collar folded into two must be within 3,5cm.

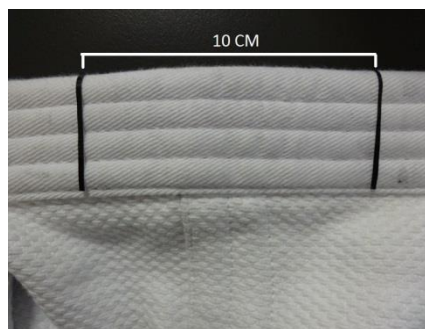

FIG. 9 A

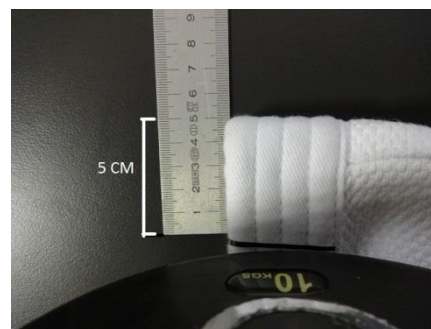

FIG. 9 B

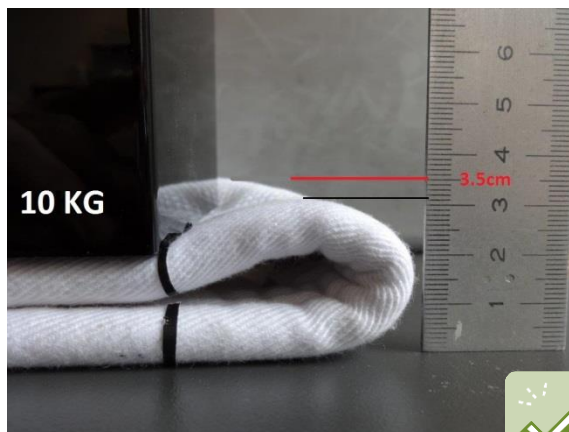

FIG. 10



- A cuff on a sleeve (turn-back of sleeve edge) must be within 3 cm wide except raised part.(Fig. 11, part C)
- Lower side of both sleeves must be sewn by rolled seam. (Fig. 11, part G)
- Reinforcement tape for jacket sleeve edge, trouser leg edge, and seaming part of upper and lower panel of jacket and some other parts must be thin cotton plain or twill weave, within 3cm wide, and use up to 3-row stitching.
- In the case of back-center seaming, the seam width must be within 3 cm. (Fig. 12, part B). Any reinforcement fabric cannot be used for the back seaming.
- Overlock stitch for fabric raw edge is allowed to prevent fray.
- Use of reinforcement pad on the back side is allowed for 3 places: shoulder, chest and armpit (only one fabric thickness for each place).



2c(1)d(1) Shoulder pad

Up to 5-row machine-stitching must be used. The vertical length of the pad must be within about 1/3 of upper back body length in front and back. The pad material must be the same Sashiko fabric as jacket fabric. (Fig. 12, part C)

2c(1)d(2) Chest pad

- Chest pad must be half oval-shaped and be attached from the base of the shoulder pad along the collar using up to 5-row stitch. The width of the chest pad must be approximately 1/4 of the jacket back-body width. (Measurement based on back-hip joint width). Excessively wide pad is not allowed. (Fig.11, part D) Pad material must be the same fabric as jacket fabric. Overlapping of shoulder pad and chest pad must be within 5cm inside the jacket.

2c(1)d(3) Armpit pad

Armpit pad must be oval-shaped and be attached using 5-row to 8-row stitch. Pad material must be the same fabric as jacket fabric, plain weave, or twill weave. (Fig. 11, part E)

- Both side slit-ends are to be sewn with covering fabric. The length of side slit must be 1/3 to 1/2 of the lower jacket part length (Fig. 13). A reinforcement fabric for above slit-ends is allowed within the size of 100 cm².

Note: Both side slits of jacket make Judo movement easier. (Only one slit in the center-back is not allowed.)

If slit is longer than 1/2 of the lower jacket part length, it will cause dishevelment.

FIG. 11 (FRONT BODY OF JUDO GI JACKET)

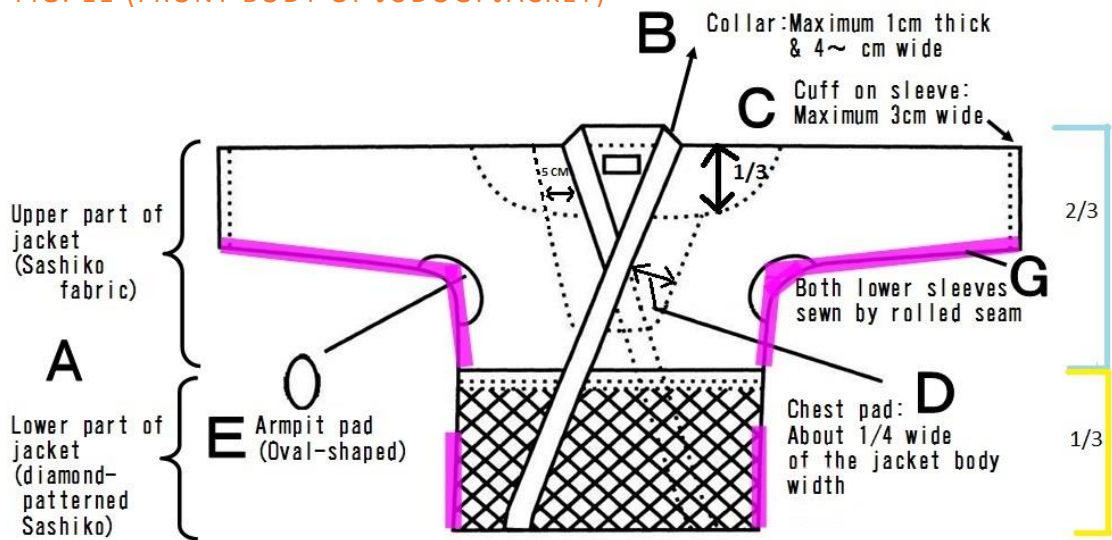

FIG. 12 (BACK BODY OF JUDO GI JACKET))

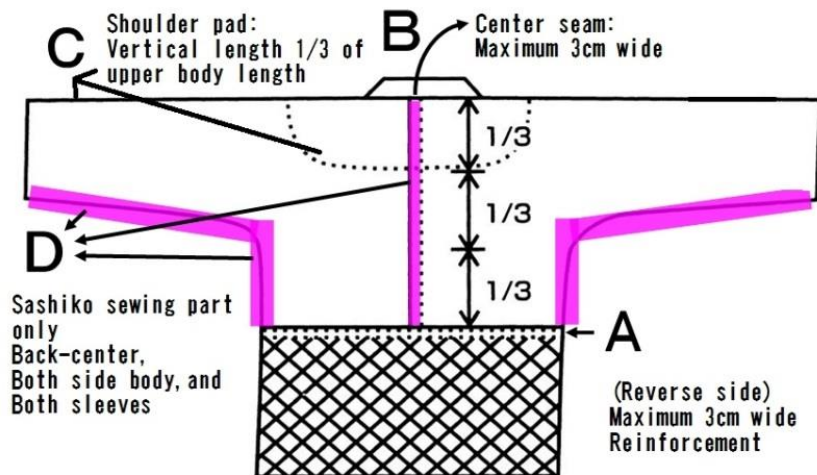
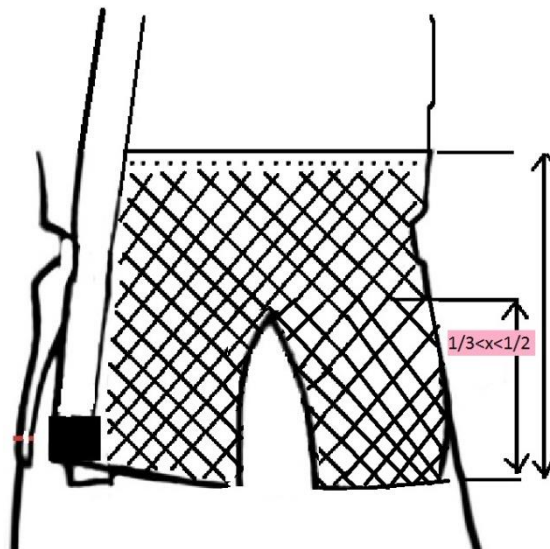

FIG. 13 THE HEIGHT OF THE SLIT ENDS (SIDE OF THE JACKET) HAS TO 1/3 TO 1/2 OF THE LOWER PART OF THE JACKET (FIG 11 PART A).



.2c(2) Trouser

- Knee pad on the fabric back must use only one layer of the same fabric as the trouser. Knee pad must be placed lower than crotch part. (Fig. 14, part A)
- The waist string must certainly be equipped. The material must be the same fabric as the trouser. Elastic material such as rubber, etc is not allowed for string. Number of string loop must be one or two. (Fig. 14, part B)
- Reinforcement lining fabric for each side slit (waist part) is allowed to be used with the same fabric as trouser. (Fig. 14, part C)
- A cuff on a trouser (turn-back of the leg edge) must be within 3 cm wide except raised part (except protuberances). Thin tape fabric within 3cm wide is allowed to be used for covering. (Fig. 14, part D)
- Gusset must be stitched onto the crotch part. (Fig. 14, part E)
- Overlock stitch for fabric raw edge is allowed to prevent fray.

FIG. 14 TROUSERS

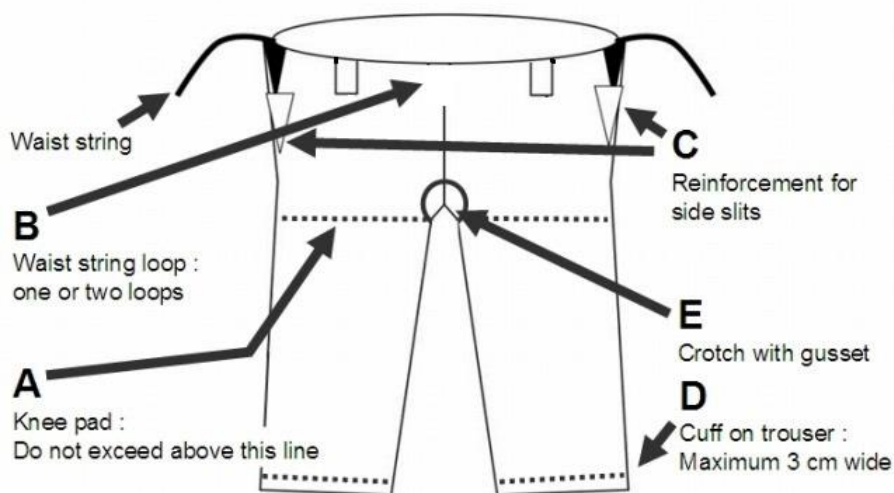

2c(3) Belt

- The belt of Judogi must use 100 % cotton fabric (A), The manufacturers must not produce such a belt as to be easily knot-loosen or broken, which can cause disturbance of the match.
- Main core material must be non-woven fabric. (must not be elastic materials such as rubber.)
- Reinforcement fabric (B) must be as specified in Fig. 15 using plain or twill weave with cotton yarn count 20/1 or lower. Sub core (D) is allowed to use as shown in Fig.15. Sub core material (center of the belt cross-section) must be the same as reinforcement fabric (B).
- The belt must be 4 to 4.5 cm wide
- The belt must be sewn using at least 8-row but no more than 13-row of straight stitch.
- The thickness of the belt must be between 4 mm and 5 mm.

FIG. 15

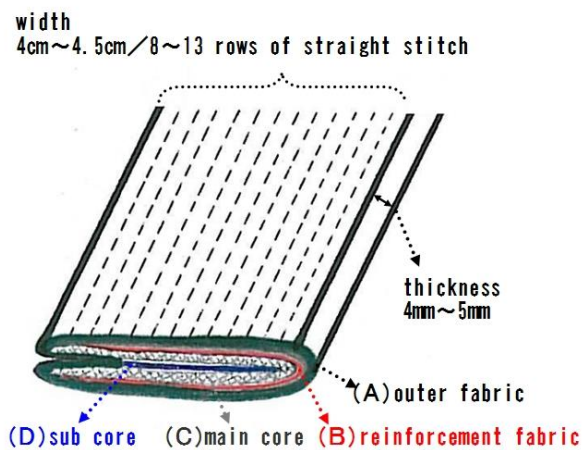
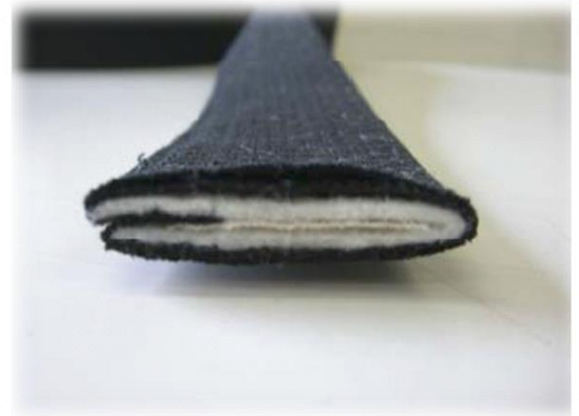

FIG 16



Note :(D) Sub core is optional.

FIG. 17



As shown in the above photo, belt should have the flexibility (softness). When pushing belt by hand from the both ends toward knot, the belt knot must not be loosening. Belt using too hard or slippery materials, which is easy to have knot loosening, is not allowed.



* For information of the back identification, any marking or advertisement on Judogi, and sizes to be measured for Judogi control, please refer to IJF Refereeing rule and IJF SOR.

3. POSITIONNING OF THE TAG

